

Instruction Manual WiFi+RF Dimmer Switch

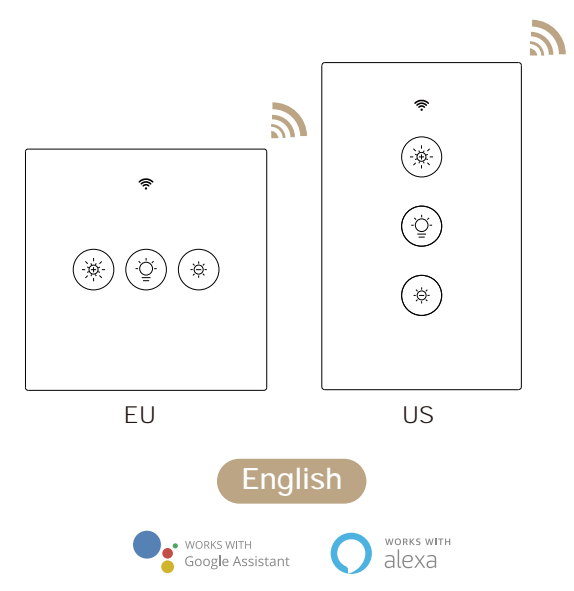

- Bitte scannen Sie den QR-Code, um das deutsche Handbuch, das Installationsvideo und die Funktionseinführung zu erhalten
- Escanee el código QR para obtener el manual en español, el video de instalación y la introducción de la función
- Veuillez scanner le code QR pour obtenir le manuel en français, la vidéo d'installation et l'introduction des fonctions
- Отсканируйте QR-код, чтобы получить руководство на русском языке, видео по установке и описание функций
- Scansionare il codice QR per ottenere il manuale in italiano, il video di installazione e la guida alle funzionalità. Video di installazione e funzionalità
- Leia o código QR para obter o manual em português, o vídeo de instalação e a introdução das funções
- Zeskanuj kod QR, aby uzyskać instrukcje, filmy instalacyjne i funkcje



English 1

Product Description

This new designed glass panel wireless touch smart switch is designed with WiFi+RF to replace traditional switches with a variety of ways to control. Now one new smart feature as new easier pairing method with Bluetooth supported is added into the Smart Life /Tuya App, together with the backlight on/off and relay status. And its scratch resistance glass panel is suitable for different decoration styles with its best value.

Note: Button sound on and off: no button operations before operations begin within 6 seconds. Then press switch button for 4 times and long press for the fourth time (20s) until the switch beep sounds as Di-Di for 2 times for successful operation.

Safety Information

Risk of Electric Shock: Electricity can cause personal injury and property damage if handled improperly. If you are not sure about any part of these instructions, please seek professional assistance from a qualified electrician.

Technical Parameters:
 Model: WS-EU-D, WS-US-D
 Working voltage: 100-250V AC, 50Hz/60Hz
 Max. total current: 1A(EU)/2A(US)
 Max. Load Power: EU:220W(220V) US:440W(220V)/220W(110V)
 Wireless type: WiFi2.4G-RF433MHz
 Working temperature: 0°C-40°C
 Support system: Android/iOS

Warnings:
 Turn off the power at the circuit breaker and test that power is off before wiring.

English 2

Installation

- Note:**
- Make sure that the power at the circuit breaker is off before wiring.
 - Neutral Wire (typically white) is required. Confirm the wall box contains a Neutral Wire. If the wall box doesn't have a Neutral Wire, please try another location at your home or call a professional electrician to install the switch.
 - The wire colors indicated in this manual are the usual colors and may differ in some houses.
 - Ensure the wire conductors are securely fastened to each wire.
 - Ensure the Wi-Fi signal is steady and normally working before wiring.
 - If you don't have any wiring experience, please call a professional electrician.

- Step 1**
- Turn off the circuit breaker and use the electrical tester to test the power.
 - Ensure the circuit breaker is off before wiring.



Attention:
 Please disconnect the power supply before installing or removing the device for avoiding irreversible damage on the device from the electric current or some unpredictable problems such as lamp flashing.

English 3

Step 2

- Remove the old switch

- Step 3**
- Remove the switch and pull it away from the wall. Identify Line/Load Wire (Note: The color of your wire may be different from the color shown on the manual.)

Verify power is off

- We recommend you remove the faceplate from the old switch and use an electrical tester to test all wires connected to the switch to ensure there is no voltage in the circuit.
- You may need to turn off more than one circuit breaker.

- Step 4**
- Take pictures of the wiring

Follow the wiring diagram to connect the switch wires to the wires in the wall box with the wire conductors.

English 4

Step 5

- Remove the panel with screwdriver (Please don't install with electricity power on)

- Step 6**
- Prepare to install wiring
 A. Live wire connects * L * terminal
 B. Neutral wire connects * N * terminal
1 Gang connects "L1" terminal
1 Gang L1 and N line.

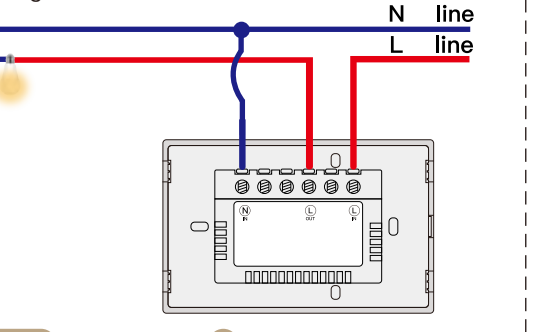

English 5

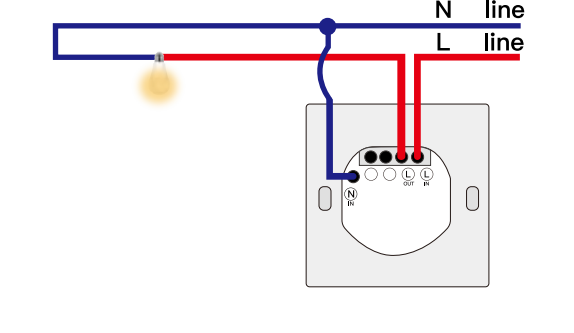

- Step 7**
- Put the switch into switch box in the wall
 - Mount the two side screws
 - Install the glass panel (install from up above)
 - Finish installation

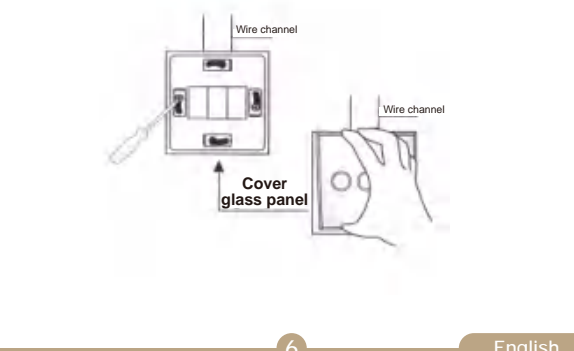

English 6

Preparation For Use

- ① Download MOES App on App store or scan the QR code



- ② Registration or Log in.
- Download "MOES" Application.
 - Enter the Register/Login interface; tap "Register" to create an account by entering your phone number to get verification code and "Set password". Choose "Log in" if you already have a MOES account.

English 7

Wi-Fi link method: (two matching methods)

- 3.1 Method one:**
 Scan the QR code to configure the network guide.

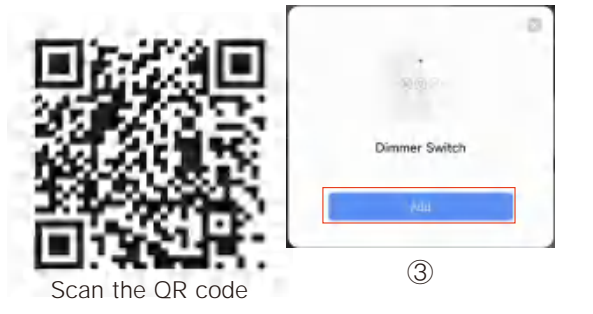
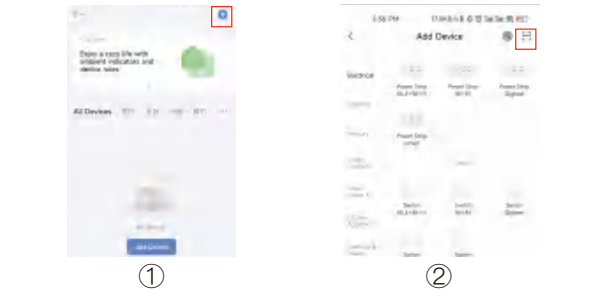

Scan the QR code
 Please connect the device according to the configuration process.

English 8

- 3.2 Method two:**
1. Make sure your phone is connected to Wi-Fi and Bluetooth.



2. Reset: Press the switch button for 6 times, and hold on the 6th time, then release until you hear Di-Di (3 times), and the blue indicator on the switch will flash fast after 3 seconds. Reset/re-pair is successful.

English 9

3. Open the MOES App, click "+" in the upper right corner, find the device to be added in the device discovery location, and click "Add".

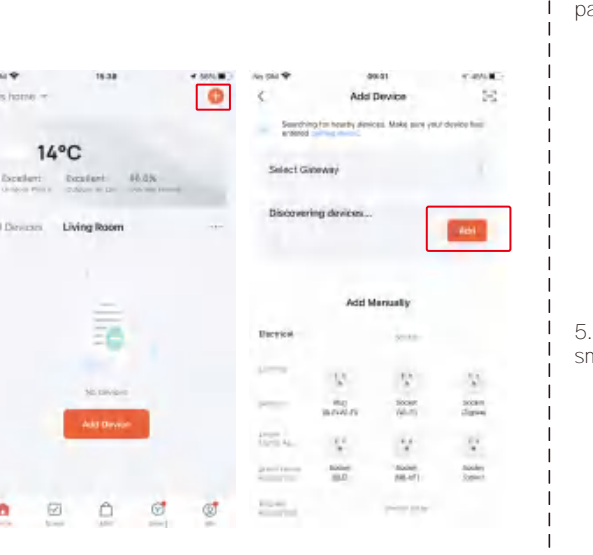

English 10

4. Enter the Wi-Fi password, click "Next", and wait for the connection to complete. Add the device successfully, you can edit the name of the device to enter the device page by click "Next"

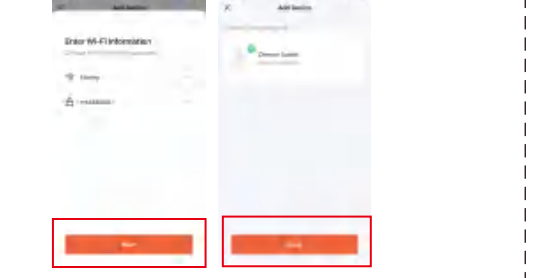

5. Click "Done" to enter the device page to enjoy your smart life with home automation

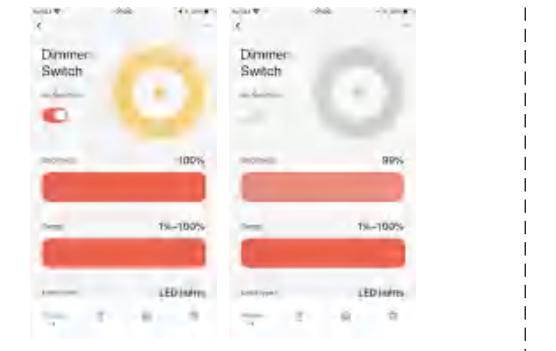

English 11

How to reset/re-pair Wi-Fi code
 Press the switch button for 6 times, and hold on the 6th time, then release until you hear Di-Di (3 times), and the blue indicator on the switch will flash fast after 3 seconds. Reset/re-pair is successful.

Remote radio frequency (RF) link method:
 Pair and clear up the RF code

1. How to pair the RF code
 Press the switch button for four times and do not release your finger on the fourth time before the beep sounds for 1 time (Di) and the indicator light flashes fast for pairing by pressing the button of the remote switch.

2. How to clear up the RF code
 Press the switch button for four times and do not release your finger on the fourth time until you hear the beep sounds 1 time (Di), then long press the button before the beep sounds four times (Di-Di-Di-Di) for successful code clearing.

Enter MOES Skill in Alexa APP

1. Complete product networking configuration in the App
 Complete the device's networking configuration according to the prompts in the App.
 Note: In the App, change the name of the device to an easily identifiable name such as Alexa; names are usually in English, such as "bed light".

English 12

2. How to connect Smart Device to Amazon Alexa.

1. Launch MOES App, sign into your account and make sure Smart Device is on the device list
2. Minimize MOES App, then launch the Alexa App and sign in your Alexa account and make sure you have at least one Alexa smart speaker-controlled device installed like Echo dot, etc.

3. In the upper left corner of Home page, press the button to show APP Menu. Then select Skills in the menu.

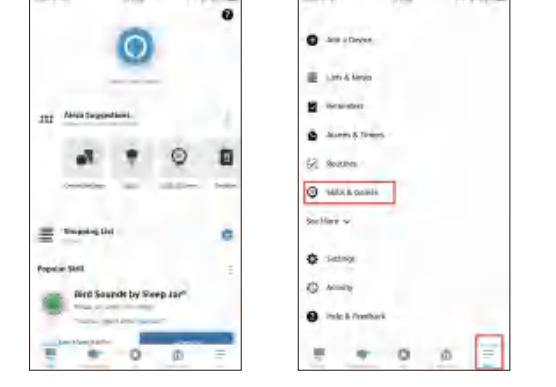

4. Type in "MOES" in the search and press the search button next to it.

English 13



5. Enable MOES Smart Skill then sign in your Smart Life account to complete your account set up.

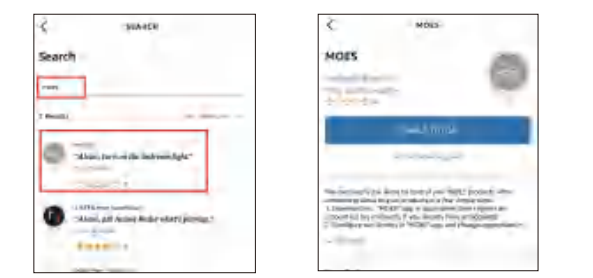

6. Once your account has been successfully linked, ask Alexa to discover devices. After a 20-second searching, Alexa will show all the available devices

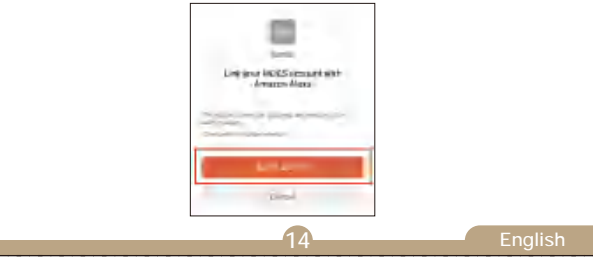

English 14

7. In the Smart Home page, you can group your devices in different categories. Your MOES APP has now been paired with Alexa. Now you can control your Smart Device through Alexa.



How to connect Smart Device to Google Home

1. Launch the Google Home App and make sure Google Home speaker is installed. If not, please follow Google Home speaker installation instruction to complete the installation.

English 15

2. Once Google Home is installed, in the upper left corner of App Home page, Pressing button to show App menu. Then press "Home Control" in the menu.

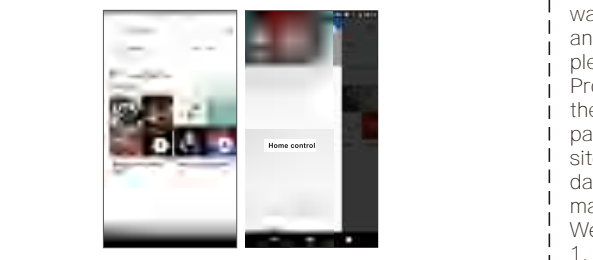

3. After successfully linking your account, in the Google Home App you can see all your smart devices from your MOES App account. You can assign rooms for each device.
4. Now you can use Google Home to control your smart device, you can say like.

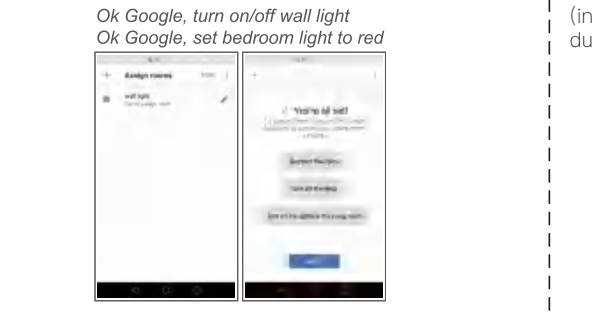

English 16

SERVICE

Thank you for your trust and support to our products, we will provide you with a two-year worry-free after-sales service (freight is not included), please do not alter this warranty service card, to safeguard your legitimate rights and interests. If you need service or have any questions, please consult the distributor or contact us.

Product quality problems occur within 24 months from the date of receipt, please prepare the product and the packaging, applying for after-sales maintenance in the site or store where you purchase; if the product is damaged due to personal reasons, a certain amount of maintenance fee shall be charged for repair.

We have the right to refuse to provide warranty service if:

1. Products with damaged appearance, missing LOGO or beyond the service term
2. Products that are disassembled, injured, privately repaired, modified or have missing parts
3. The circuit is burned or the data cable or power interface is damaged
4. Products damaged by foreign matter intrusion (including but not limited to various forms of fluid, sand, dust, soot, etc.)

RECYCLING INFORMATION

All products marked with the symbol for separate collection of waste electrical and electronic equipment (WEEE Directive 2012/19 / EU) must be disposed of separately from unsorted municipal waste.

To protect your health and the environment, this equipment must be disposed of at designated collection points for electrical and electronic equipment designated by the government or local authorities.

Correct disposal and recycling will help prevent potential negative consequences for the environment and human health. To find out where these collection points are and how they work, contact the installer or your local authority.



English 18

WARRANTY CARD

Product Information

Product Name _____

Product Type _____

Purchase date _____

Warranty Period _____

Dealer Information

Customer's Name _____

Customer Phone _____

Customer Address _____

Maintenance Records

Failure date	Cause Of Issue	Fault Content	Principal

English 19

Thank you for your support and purchase at we Moes, we are always here for your complete satisfaction, just feel free to share your great shopping experience with us.



If you have any other need, please do not hesitate to contact us first, we will try to meet your demand.

FOLLOW US

Facebook: @moessmart
 Twitter: @moes_smart
 Instagram: @moes_smart

YouTube: MOES.Official
 TikTok: @moes_smart
 Website: www.moes.net

English 20

UK REP EVATOST CONSULTING LTD
 Address: Suite 11, First Floor, Moy Road Business Centre, Taffs Well, Cardiff, Wales, CF15 7QR
 Tel: +44-292-1680945
 Email: contact@evatmaster.com

EC REP AMZLAB GmbH
 Laubenhof 23, 45326 Essen
 Made In China

Manufacturer:
 WENZHOU NOVA NEW ENERGY CO.,LTD
 Address: Power Science and Technology Innovation Center, NO.238, Wei 11 Road, Yueqing Economic Development Zone, Yueqing, Zhejiang, China
 Tel: +86-577-57186815
 After-sale Service: service@moeshouse.com

English 21